

JVC



LYT2096-001B-M

ENGLISH

EN

INSTRUCTIONS

HD MEMORY CAMERA

GZ-HM400 **U**

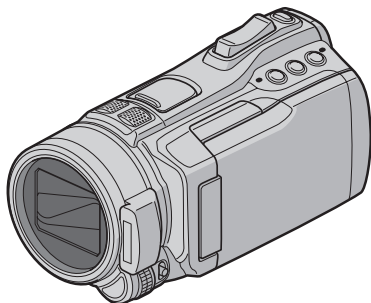

Dear Customers

Thank you for purchasing this camcorder. Before use, please read the safety information and precautions contained in pages 2 and 3 to ensure safe use of this product.

For Future Reference:

Enter the Model No. (located on the bottom of the camcorder) and Serial No. (located on the battery pack mount of the camcorder) below.

Model No. _____

Serial No. _____

Read these **INSTRUCTIONS** to enjoy your CAMCORDER. For more details on the operations, refer to the **Advanced INSTRUCTIONS** in the supplied CD-ROM.



Safety Precautions



CAUTION
RISK OF ELECTRIC SHOCK
DO NOT OPEN



CAUTION: TO REDUCE THE RISK OF ELECTRIC SHOCK,
DO NOT REMOVE COVER (OR BACK).
NO USER-SERVICEABLE PARTS INSIDE.
REFER SERVICING TO QUALIFIED SERVICE PERSONNEL.



The lightning flash with arrowhead symbol, within an equilateral triangle, is intended to alert the user to the presence of uninsulated "dangerous voltage" within the product's enclosure that may be of sufficient magnitude to constitute a risk of electric shock to persons.



The exclamation point within an equilateral triangle is intended to alert the user to the presence of important operating and maintenance (servicing) instructions in the literature accompanying the appliance.

WARNING: TO PREVENT FIRE OR SHOCK HAZARD, DO NOT EXPOSE THIS UNIT TO RAIN OR MOISTURE.

NOTES:

- The rating plate and safety caution are on the bottom and/or the back of the main unit.
- The serial number plate is on the battery pack mount.
- The rating information and safety caution of the AC adapter are on its upper and lower sides.

Caution on Replaceable lithium battery

The battery used in this device may present a fire or chemical burn hazard if mistreated.

Do not recharge, disassemble, heat above 100°C or incinerate.

Replace battery with Panasonic, Sanyo, Sony or Maxell CR2025.

Danger of explosion or Risk of fire if the battery is incorrectly replaced.

- Dispose of used battery promptly.
- Keep away from children.
- Do not disassemble and do not dispose of in fire.

For USA-California Only

This product contains a CR Coin Cell Lithium Battery which contains Perchlorate Material – special handling may apply.

See www.dtsc.ca.gov/hazardouswaste/perchlorate

When the equipment is installed in a cabinet or on a shelf, make sure that it has sufficient space on all sides to allow for ventilation (10 cm (3-15/16") or more on both sides, on top and at the rear).

Do not block the ventilation holes.

(If the ventilation holes are blocked by a newspaper, or cloth etc. the heat may not be able to get out.)

No naked flame sources, such as lighted candles, should be placed on the apparatus.

When discarding batteries, environmental problems must be considered and the local rules or laws governing the disposal of these batteries must be followed strictly.

The apparatus shall not be exposed to dripping or splashing.

Do not use this equipment in a bathroom or places with water.

Also do not place any containers filled with water or liquids (such as cosmetics or medicines, flower vases, potted plants, cups etc.) on top of this unit. (If water or liquid is allowed to enter this equipment, fire or electric shock may be caused.)

Do not point the lens directly into the sun. This can cause eye injuries, as well as lead to the malfunctioning of internal circuitry. There is also a risk of fire or electric shock.

CAUTION!

The following notes concern possible physical damage to the camcorder and to the user.

Carrying or holding the camcorder by the LCD monitor can result in dropping the unit, or in a malfunction.

Do not use a tripod on unsteady or unlevel surfaces.

It could tip over, causing serious damage to the camcorder.

CAUTION!

Connecting cables (Audio/Video, S-Video, etc.) to the camcorder and leaving it on top of the TV is not recommended, as tripping on the cables will cause the camcorder to fall, resulting in damage.

CAUTION:

The mains plug shall remain readily operable.

- Remove the mains plug immediately if the camcorder functions abnormally.

WARNING:

The battery pack, the camcorder with battery installed, and the remote control with battery installed should not be exposed to excessive heat such as direct sunshine, fire or the like.

IMPORTANT SAFETY INSTRUCTIONS

1. Read these instructions.
2. Keep these instructions.
3. Heed all warnings.
4. Follow all instructions.
5. Do not use this apparatus near water.
6. Clean only with dry cloth.
7. Do not block any ventilation openings. Install in accordance with the manufacturer's instructions.
8. Do not install near any heat sources such as radiators, heat registers, stoves, or other apparatus (including amplifiers) that produce heat.
9. Only use attachments/accessories specified by the manufacturer.
10. Use only with the cart, stand, tripod, bracket, or table specified by the manufacturer, or sold with the apparatus. When a cart is used, use caution when moving the cart/apparatus combination to avoid injury from tip-over.
11. Unplug this apparatus during lightning storms or when unused for long periods of time.
12. Refer all servicing to qualified service personnel. Servicing is required when the apparatus has been damaged in any way, such as power-supply cord or plug is damaged, liquid has been spilled or objects have fallen into the apparatus, the apparatus has been exposed to rain or moisture, does not operate normally, or has been dropped.

**Remember that this camcorder is intended for private consumer use only.**

Any commercial use without proper permission is prohibited. (Even if you record an event such as a show, performance or exhibition for personal enjoyment, it is strongly recommended that you obtain permission beforehand.)

Trademarks

- "AVCHD" and the "AVCHD" logo are trademarks of Panasonic Corporation and Sony Corporation.
- Manufactured under license from Dolby Laboratories. Dolby and the double-D symbol are trademarks of Dolby Laboratories.
- x.v.Color™ is a trademark of Sony Corporation.
- HDMI is a trademark of HDMI Licensing, LLC.
- Windows® is either registered trademark or trademark of Microsoft Corporation in the United States and/or other countries.
- Macintosh is a registered trademark of Apple Inc.
- iTunes, iMovie, iPhoto are trademarks of Apple Inc., registered in the U.S. and other countries.
- YouTube and the YouTube logo are trademarks and/or registered trademarks of YouTube LLC.
- Other product and company names included in this instruction manual are trademarks and/or registered trademarks of their respective holders.



If this symbol is shown, it is only valid in the European Union.

Charge the battery before recording

Turn off the camcorder and attach the battery pack.

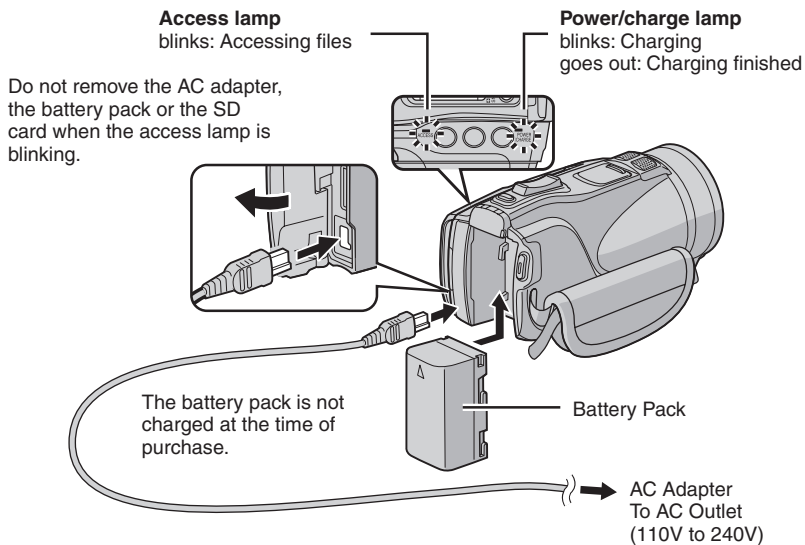

CAUTION

Fire or injury may result if batteries NOT approved by JVC are used. Only use the batteries specified on page 41.

Date/Time Setting

- 1** Open the LCD monitor to turn on the camcorder

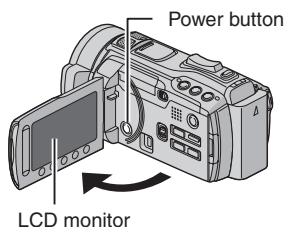

- 2** Select [YES] within 10 seconds

Slide your finger up and down on the sensor. Then touch OK.

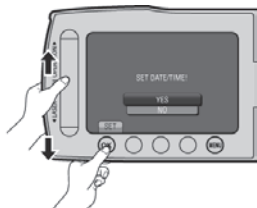

- When the message disappears, press the power button for at least 2 seconds to turn off the power, and then press it again for at least 2 seconds.
- Touch the sensors with your finger. The sensors do not function if you touch them with your finger nail or with gloves on.

- 3** Select [CLOCK SETTING]

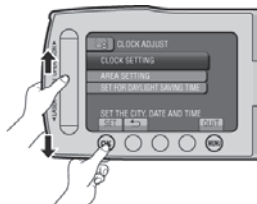

- 4** Select the city closest to the area where you use the camcorder

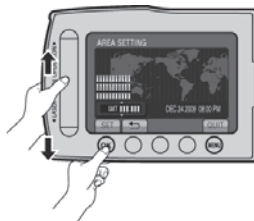

- 5** Select [ON] if daylight saving time is observed

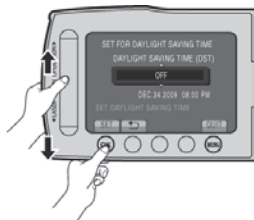

- 6** Set the date and time

Touch sensor: Sets the date and time
→: Moves the cursor to the right
OK: Clock starts

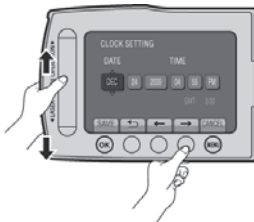

Video recording

CAUTION

Before recording an important scene, it is recommended to conduct a trial recording.

1 Slide the mode switch to select (video) mode

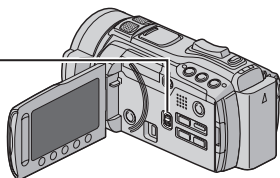

2 Select recording mode (REC)



The mode changes when you press the button.

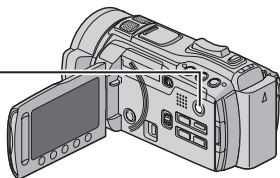

The auto recording indicator appears.



3 Start recording



Press the **START/STOP** button to start recording, and press it again to stop.

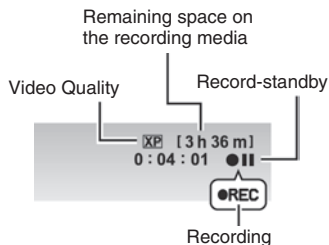
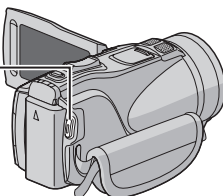

Playing back

1 Select playback mode (PLAY)



The mode changes when you press the button.

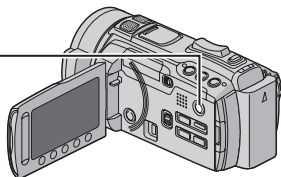

2 Select the desired file

Index screen



3 Select ► (Touch OK)

Playback screen



- To perform operations such as forward search or reverse search (⇨ p. 22)
- To view files on TV (⇨ p. 24)

CAUTION

Do not forget to make copies after recording!

- To copy files onto discs (⇨ p. 26)
- To dub files to a VCR/DVD recorder (⇨ p. 28)
- To edit files on your computer (⇨ p. 29)

Contents

GETTING STARTED

Accessories	10
Shoe Adapter.....	10
Preparing the Remote Control.....	11
Attaching the Core Filter to the USB Cable... 11	
Index	12
Tripod Mounting.....	13
Indications on LCD Monitor	14
Necessary Settings before Use	16
Charging the Battery Pack.....	16
Date/Time Setting.....	16
Language Setting	17
Grip Adjustment.....	17
Other Settings	18
Using an SD Card.....	18

RECORDING/PLAYBACK

Recording Files	19
Video Recording	19
Still Image Recording	20
Zooming.....	21
Flash.....	21
Checking the Remaining Space on the Recording Media	21
Checking the Remaining Battery Power	21
Playing Back Files	22
Video Playback	22
Still Image Playback	23

USING WITH TV

Viewing Files on TV	24
Connection with TV.....	24
Playback Operation	25

COPYING

Copying Files	26
Using a BD/DVD Burner	26
Dubbing Files to a VCR/DVD Recorder	28

PC OPERATION

Creating a Disc Using a PC	29
Using with a Portable Media Player	34
Turning on the Export Mode	34
Making the Export Setting	34
Transferring the Files to PC	34
Uploading Files to Websites	35
Turning on the Upload Mode	35
Uploading Files.....	35

FURTHER INFORMATION

Changing the Menu Settings	36
Troubleshooting	36
Warning Indications	38
Specifications	39
Cautions	42
Terms	44

Read these **INSTRUCTIONS** to enjoy your CAMCORDER.
For more details on the operations, refer to the **Advanced INSTRUCTIONS** in the supplied CD-ROM.

In order to view the **Advanced INSTRUCTIONS**, Adobe® Acrobat® Reader™ or Adobe® Reader® must be installed.

Adobe® Reader® can be loaded from Adobe's web site:
<http://www.adobe.com/>

NOTE

Select your desired language with a single click.
The model name is indicated on the bottom of your camcorder.



How to use the Touch Sensor

After the menu is displayed on the LCD monitor:

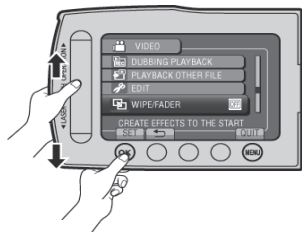

- 1 Slide your finger up and down on the sensor.
- 2 Select [SET]. (Touch OK.)

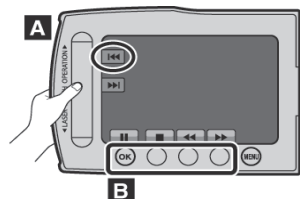

- A** To select an on-screen button appearing on the left side, touch the portion of the sensor next to the on-screen button.
- B** To select an on-screen button appearing at the bottom of the screen, touch the buttons underneath them.

Read This First!

Make a backup of important recorded data

It is recommended to copy your important recorded data to a DVD or other recording media for storage. JVC will not be responsible for any lost data.

Make a trial recording

Before the actual recording of important data, make a trial recording and play back the recorded data to check that the video and sound have been recorded correctly.

Reset the camcorder if it does not operate correctly

Close the LCD monitor and remove the power supply (battery pack or AC adapter) from the camcorder, then reattach it.

Precautions on handling batteries

- Be sure to use the JVC BN-VF808U/VF815U/VF823U battery packs. This product includes patented and other proprietary technology and is made to be used with the JVC battery and not with other batteries. JVC cannot guarantee safety or performance of this product when it is operated by other batteries.
- If the camcorder is subjected to electrostatic discharge, turn off the power before using it again.

If a malfunction occurs, stop using the camcorder immediately and contact www.jvc.com or by phone at 1-800-252-5722

- Recorded data may be erased while the camcorder is being repaired or inspected. Back up all data before requesting repairs or inspections.

Because camcorders may be used for demonstration in a shop, the demonstration mode is set to on by default
To deactivate the demonstration mode, set [DEMO MODE] to [OFF].

Accessories

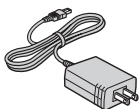

AP-V21U
AC Adapter

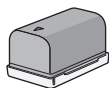

BN-VF815U
Battery Pack



Component Cable



AV Cable



USB Cable



LY37115-001A
Shoe Adapter



RM-V751U
Remote Control



CR2025
Lithium Battery
Pre-installed in the
remote control.



CD-ROM



Core Filter

Shoe Adapter

An optional microphone or light can be attached to the shoe adapter.

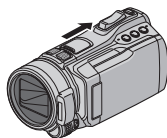

Slide the shoe cover in the direction of the arrow to reveal the shoe adapter mounting socket.



Mount the accessory shoe adapter.

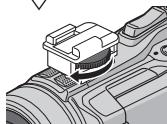
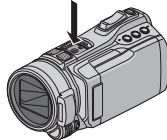

Fasten the shoe adapter to the shoe adapter mounting socket by turning the screw in the direction of the arrow.

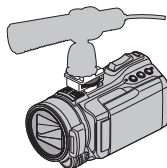

Insert a microphone, etc. from behind the shoe adapter.

NOTE

Do not try to attach a microphone, etc. to the shoe adapter forcibly.

NOTE

Make sure to use the provided cables for connections. Do not use any other cables.

Preparing the Remote Control

A battery is included inside the remote control at the time of purchase. Remove the insulation sheet before use.

Beam Effective Area

Remote Sensor

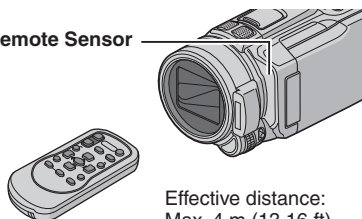

Effective distance:
Max. 4 m (13.16 ft)

NOTE

The transmitted beam may not be effective or may cause incorrect operation when the remote sensor is directly exposed to sunlight or powerful lighting.

To Reinsert the Battery

Pull out the battery holder by pressing the lock tab.

Lock Tab

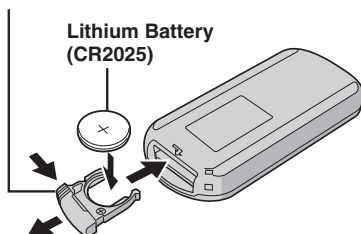

Attaching the Core Filter to the USB Cable

The core filter reduces interference caused when connecting to other devices. Connect the end of the cable with the core filter to the camcorder.

Release the stopper.

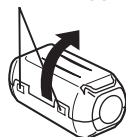

3 cm (1-3/16")

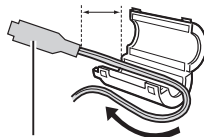

To be connected to
the camcorder

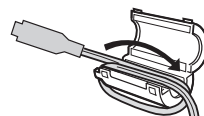

Wind once.

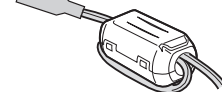

Index

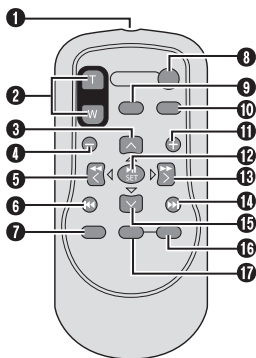
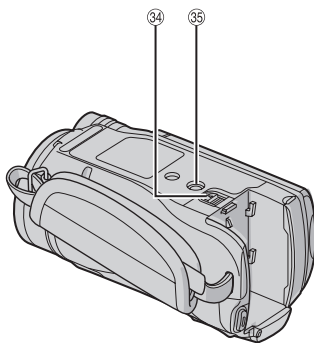
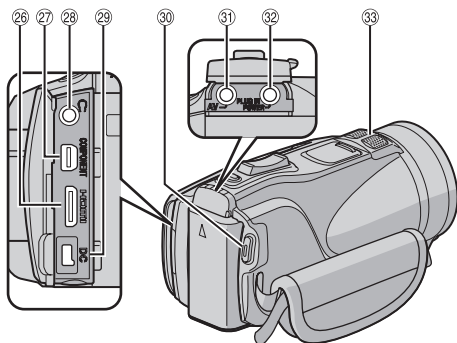
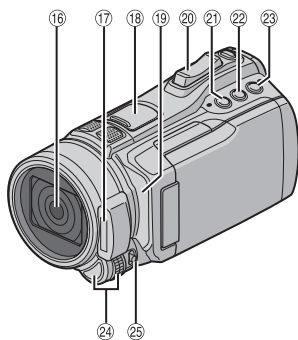
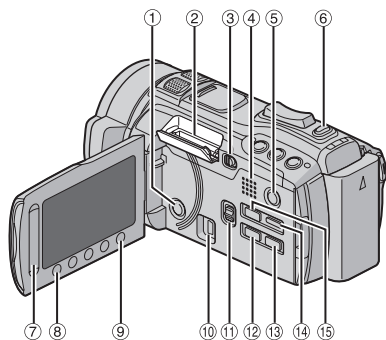

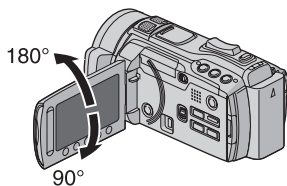

NOTE

- Be careful not to cover 16, 17, 19, and 33 during shooting.
- The LCD monitor can rotate 270°.



Camcorder

- ① Power Button
- ② SD Card Slot
- ③ **OPEN** knob (⇨ p. 18)
- ④ Speaker
- ⑤ **PLAY/REC** Button (⇨ p. 19, 20, 22, 23)
- ⑥ **SNAPSHOT** Button (⇨ p. 20)
- ⑦ Touch Sensor
- ⑧ **OK** Button
- ⑨ **MENU** Button (⇨ p. 36)
- ⑩ USB Connector (⇨ p. 26, 30)
- ⑪ Mode Switch 
- ⑫ **EXPORT** Button (⇨ p. 34)
- ⑬ **DIRECT DISC** Button (⇨ p. 27)
- INFO** Button (⇨ p. 21)
- ⑭ **DISPLAY** Button (⇨ p. 15)
- ⑮ **UPLOAD** Button (⇨ p. 35)
- TITLE** Button
- ⑯ Lens
- ⑰ Flash (⇨ p. 21)
- ⑱ Shoe Adapter Mounting Socket (⇨ p. 10)
- ⑲ Remote Sensor
- ⑳ Zoom Lever (⇨ p. 21)
- Speaker Volume Control
- ㉑ Aperture Priority Setting Button [**A**]
- ㉒ Shutter Speed Button [**S**]
- ㉓ **USER** Button [**U**]
- ㉔ Adjustment dial/**SET** Button
- ㉕ **FOCUS/BRIGHT** Switch
- ㉖ HDMI Mini Connector (⇨ p. 24)
- ㉗ Component Connector (⇨ p. 24)
- ㉘  (headphones) Connector
- ㉙ DC Connector
- ㉚ **START/STOP** Button (⇨ p. 19)
- ㉛ AV Connector (⇨ p. 25, 28)
- ㉜ MIC (microphone) Connector
- ㉝ Stereo Microphone
- ㉞ Battery Release Button (⇨ p. 16)
- ㉟ Tripod Mounting Socket

Remote Control

- ① Infrared Beam Transmitting Window
- ② **ZOOM (T/W)** Buttons (Zoom in/Out)
- ③ Up Button
- ④ Skip Backward Button
- ⑤ Left Button
- ⑥ Back Button
- ⑦ **PLAYLIST** Button
- ⑧ **START/STOP** Button
- ⑨ **S.SHOT(SNAPSHOT)** Button
- ⑩ **INFO** Button
- ⑪ Skip Forward Button
- ⑫ **PLAY/PAUSE/SET** Button
- ⑬ Right Button
- ⑭ Next Button
- ⑮ Down Button
- ⑯ **INDEX** Button*
- ⑰ **DISP** Button

* Each time you press **INDEX**, the screen switches as shown below:

 mode:
Index Screen ↔ Group Index Screen

 mode:
Index Screen ↔ Date Index Screen

Tripod Mounting

Align the camcorder stud hole with the tripod stud, and the mounting socket with the screw, and then rotate the camcorder clockwise to mount it to the tripod.

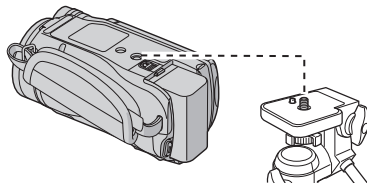

NOTE

Do not use a tripod on unsteady or unlevel surfaces. It could tip over, causing serious damage to the camcorder.

Indications on LCD Monitor

During both Video and Still Image Recording

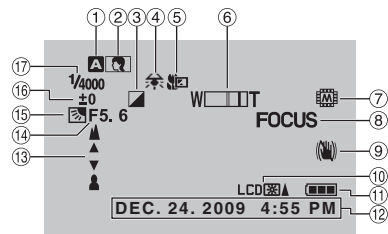

- ① Selected Recording Mode Indicator (⇨ p. 19, 20)
A: Auto Mode
M: Manual Mode
- ② Scene Select Indicator
- ③ Effect Mode Indicator
- ④ White Balance Indicator
- ⑤ Tele Macro Mode Indicator
- ⑥ Zoom Indicator (⇨ p. 21)
- ⑦ Recording Medium Indicator
- ⑧ Focus Assist Indicator
- ⑨ Optical Image Stabilizer (OIS) Indicator (Appears when [OIS] is set to [OFF].)
- ⑩ Monitor Backlight Indicator
- ⑪ Battery Indicator
- ⑫ Date/Time (⇨ p. 16)
- ⑬ Manual Focus Adjustment Indicator
- ⑭ Aperture Value (F-number)
- ⑮ Backlight Compensation Indicator
A: Face Detection indicator
- ⑯ Brightness Control Indicator
: Photometry Area Control Indicator
- ⑰ Shutter Speed

During Video Recording Only

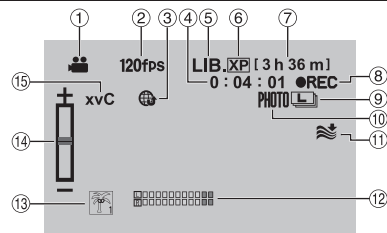

- ① Mode Indicator
- ② High Speed Recording Indicator
- ③ Upload Mode Indicator (⇨ p. 35)
- ④ Counter
- ⑤ Export Mode Indicator (⇨ p. 34)
- ⑥ Video Quality
- ⑦ Remaining Time
- ⑧ ● REC: (Appears during recording.)
 ●■■: (Appears during record-standby mode.)
- ⑨ Continuous Shooting Indicator
- ⑩ Shooting Indicator (⇨ p. 19)
- ⑪ Wind Cut Indicator
- ⑫ Microphone Input Level Indicator
- ⑬ Event Indicator
- ⑭ Sharpness Indicator
- ⑮ x.v.Color™

During Still Image Recording Only

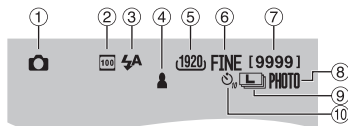

- ① Mode Indicator
- ② ISO Sensitivity Indicator (When [GAIN] is set to [AUTO], there is no indication.)
- ③ Flash Indicator (⇨ p. 21)
- ④ Focus Indicator (⇨ p. 20)
- ⑤ Image Size
- ⑥ Image Quality: FINE (fine) or STD (standard)
- ⑦ Remaining Number of Shots
- ⑧ Shooting Indicator (⇨ p. 20)
- ⑨ Continuous Shooting Indicator
: Bracketing Indicator
- ⑩ Self-Timer Indicator

During Video Playback

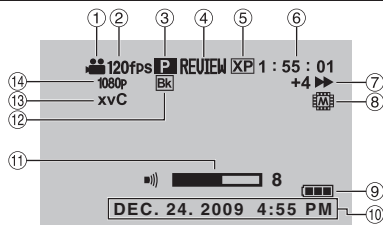

- ① Mode Indicator
- ② High Speed Recording Indicator
- ③ Playlist Playback Indicator (Appears when playing back a playlist.)
- ④ Quick Review Indicator (⇐ p. 19)
- ⑤ **DIGEST**: Digest Playback Indicator
- ⑥ Video Quality
- ⑦ Counter
- ⑧ Playback Mode
 - ▶ : Playback
 - ⏸ : Pause
 - ▶▶ : Forward Search
 - ◀◀ : Reverse Search
 - ▶▶▶ : Forward Slow-Motion
 - ◀◀◀ : Reverse Slow-Motion
 (The number on the left shows speed.)
- ⑨ Recording Medium Indicator
- ⑩ Battery Indicator
- ⑪ Date/Time (⇐ p. 16)
- ⑫ Volume Level Indicator
- ⑬ Wipe/Fader Effect Indicator
- ⑭ x.v.Color™
- ⑮ Output with 1080p

During Still Image Playback

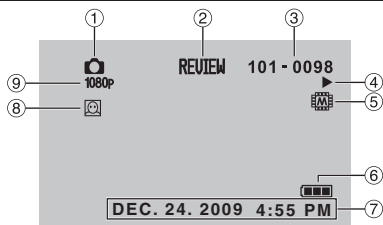

- ① Mode Indicator
- ② Quick Review Indicator (⇐ p. 20)
- ③ Folder/File Number
- ④ Slide Show Playback Indicator
- ⑤ Recording Medium Indicator
- ⑥ Battery Indicator
- ⑦ Date/Time (⇐ p. 16)
- ⑧ Face Detection Zoom Indicator
- ⑨ Output with 1080p

Switching indication modes on LCD monitor

Each time you touch **DISPLAY**, indications on LCD monitor switch as shown below:

In recording mode:

All indications/Indications for selected functions

In playback mode:

All indications/Only date and time/No indications

Necessary Settings before Use

GETTING STARTED

Charging the Battery Pack

- 1 Close the LCD monitor to turn off the camcorder.
- 2 Attach the battery pack, then connect the AC adapter.

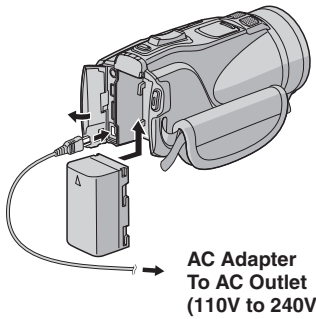

- The power/charge lamp blinks to indicate charging has started.
- When the lamp goes out, charging is finished.

Battery pack	Charging time	Recording time
BN-VF808U	1 h 50 m	1 h 10 m
BN-VF815U (Provided)	2 h 40 m	2 h 25 m
BN-VF823U	3 h 40 m	3 h 40 m

- To check the remaining battery power See page 21.
- To detach the battery pack

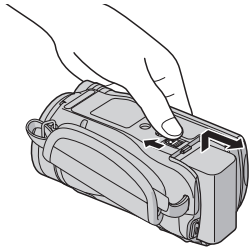

NOTE

- You can also use the camcorder with just the AC adapter.
- The actual recording time may shorten depending on the recording environment, such as when recording scenes with fast moving subject.
- Please do not pull or bend the AC adapter plug and cable. This may damage the AC adapter.

Date/Time Setting

- 1 Open the LCD monitor to turn on the camcorder.
- 2 Touch MENU.
- 3 Select [DISPLAY SETTINGS].



- 4 Select [CLOCK ADJUST].



- 5 Select [CLOCK SETTING].



- 6 Select the city closest to the area where you use the camcorder.

Selected area is highlighted

Principal city of the selected area
Time difference to GMT



- 7** Select [ON] if daylight saving time is observed.

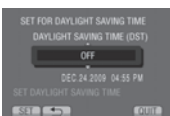

- 8** Set the date and time.
Change the setting by using the touch sensor and select [→] to set.



- 9** Select [SAVE].
To reset the setting, select [CANCEL].

Setting the clock to local time when traveling

After performing steps 1-4 (p. 16)

- 5** Select [AREA SETTING].

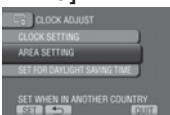

- 6** Select the city closest to the area you are traveling.



- To return to the previous screen
Select [←].

- To quit the screen
Select [QUIT].

Language Setting

The language on the display can be changed.

- 1 Open the LCD monitor to turn on the camcorder.
- 2 Touch MENU.
- 3 Select [DISPLAY SETTINGS].



- 4 Select [LANGUAGE].

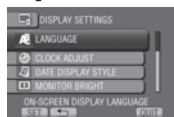

- 5 Select the desired language.

- To return to the previous screen
Select [←].
- To quit the screen
Select [QUIT].

Grip Adjustment

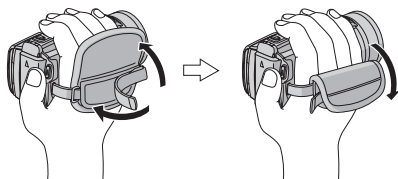

NOTE

- Fasten the strap when you grip the camcorder.
- When carrying the camcorder, please be careful not to drop it.

Other Settings

Using an SD Card

The camcorder is programmed to record on the built-in memory when it is shipped from the factory. You can change the recording medium to an SD card.

- Operations are confirmed on the following SD cards.
 - Panasonic
 - TOSHIBA
 - SanDisk
 - ATP

Video recording:

Class 4 or higher compatible SDHC card (4 GB to 32 GB)

Still image recording:

SD card (256 MB to 2 GB) or SDHC card (4 GB to 32 GB)

- Operations are not guaranteed if any other SD card than the mentioned above is used.
- If other media are used, they may fail to record data correctly, or they may lose data that had already been recorded.
- MultiMediaCards are not supported.
- Video data may not be recorded onto the SD cards on which video data have already been recorded using the devices from other manufacturers.
- It is recommended to use Class 6 when recording video in UXP mode.

NOTE

No SD card is supplied with your camcorder.

Insert an SD card

Preparation:

Press the  (Power) button for more than 2 seconds to turn off the camcorder.

- 1 Slide the **OPEN knob** to open the SD card cover.
- 2 Firmly insert the card with its clipped edge first.

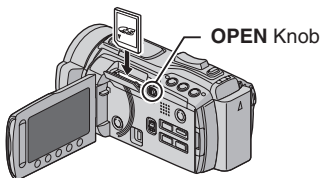

- 3 Close the SD card cover.



To remove an SD card

Push the SD card once.

After the card comes out a little, pull it out.

NOTE

- Insert and remove the SD card only while the power is turned off. Otherwise, data on the card may be corrupted.
- Do not touch the terminal on the reverse side of the label.

Change the recording medium

Set **[MEDIA SETTINGS]** → **[REC MEDIA FOR VIDEO]** and **[REC MEDIA FOR IMAGE]** to **[SD CARD]**.



Format an SD card when using it for the first time

Select **[MEDIA SETTINGS]** → **[FORMAT SD CARD]** to format the card.



Recording Files

Video Recording

1 Slide the mode switch to select  (video) mode.

2 Press **PLAY/REC** to select the recording mode.

3 Press **START/STOP** to start recording.

SNAPSHOT

PLAY/REC

START/STOP

XP [3 h 36 m]
0 : 00 : 00 ● II

XP [3 h 36 m]
0 : 00 : 01 ● REC

Approximate remaining time for recording

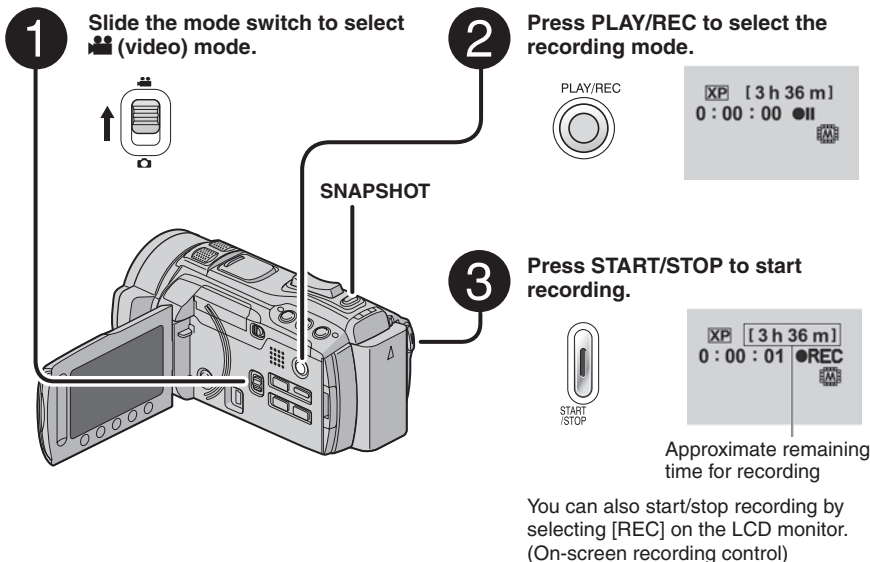

You can also start/stop recording by selecting [REC] on the LCD monitor. (On-screen recording control)



■ To stop recording

Press **START/STOP** again.

■ To view the last recorded scene

Select  while recording is paused. Selecting  during playback deletes that scene.

■ To record a still image during video recording

Press **SNAPSHOT**.

■ To change the video quality

Change the settings in [VIDEO QUALITY].

■ To change the manual recording mode

Select [A/M] twice.



NOTE

- The video recording mode is automatically selected when you turn off the camcorder and then turn on again.
- If the camcorder is not operated for 5 minutes while the power is on, it turns itself off automatically to conserve power.

Recording Files (Continued)

Still Image Recording

RECORDING/PLAYBACK

- 1** Slide the mode switch to select  (still image) mode.



- 2** Press PLAY/REC to select the recording mode.



FINE [9999]

- 3** Press and hold SNAPSHOT halfway.



FINE 



The  indicator becomes green when the captured image is focused.

- 4** Press SNAPSHOT fully to take a still image.



FINE [9999]



- **To view the last recorded image**
Select  after shooting.
Selecting  during playback deletes that image.
- **To change the image quality**
Change the settings in [IMAGE QUALITY].
- **To change the image size**
Change the settings in [IMAGE SIZE].
- **To record still images continuously**
Set to [CONTINUOUS SHOOTING] in [SHUTTER MODE].
- **To change the manual recording mode**
Select [A/M] twice.



NOTE

- If the camcorder is not operated for 5 minutes while the power is on, it turns itself off automatically to conserve power.
- The sides of still images recorded in 16:9 size may be cut off when printed. Check whether 16:9 size prints can be printed at your local print store.

Zooming

Preparation:

- Select or mode.
- Select the recording mode.

Zoom in



T: Telephoto

Zoom out

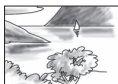

W: Wide angle



You can also zoom out/zoom in by selecting [W] or [T] on the LCD monitor. (On-screen zoom control)

Zoom ratio (factory-preset)

mode	mode
[10X/OPTICAL]	[10X/OPTICAL]

To change the maximum zoom ratio (person mode only)

Change the settings in [ZOOM].

NOTE

Macro shooting is possible as close as approx. 5 cm (2") to the subject when the zoom lever is set all the way to **W**.

Flash

Preparation:

- Select mode.
- Select the recording mode.

1 Touch MENU.

2 Select [FLASH].

3 Select the desired setting.

OFF	Disables this function.
AUTO	The flash fires automatically.
AUTO RED-EYE	The flash fires automatically but reduces the red-eye phenomenon of the subject's eyes.
ON	The flash fires regardless of the shooting condition.
SLOW SYNCHRO	The flash fires. The shutter speed becomes slower, so that background can also be brightened.

NOTE

- The flash does not work during [CONTINUOUS SHOOTING] and [BRACKETING].
- The flash does not work with the following SCENE SELECT settings. [LANDSCAPE] [TWILIGHT] [NIGHT] [SNOW] [BEACH] [FIREWORKS] [SUNSET]
- It is recommended shoot distance within 2 m (6.6 ft).

Checking the Remaining Space on the Recording Media

Preparation:

- Select mode.
- Select the recording mode.

Press **INFO**.

Selected recording medium only

DIRECT DISC



INFO



The maximum recording time is displayed for each video quality mode.

To change the video quality

- 1) Select the video quality.
- 2) Select [SET].

To quit the screen

Select [QUIT].

Checking the Remaining Battery Power

mode:

Press **INFO** and then select .

mode:

Press **INFO**.

DIRECT DISC



INFO



To quit the screen

Select [QUIT] or press **INFO**.

NOTE

The recordable time display should only be used as a guide. It is displayed in 10 minute units.

Playing Back Files

Video Playback

- 1** Slide the mode switch to select  (video) mode.



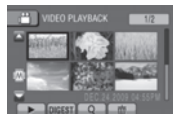

- 2** Press **PLAY/REC** to select the playback mode.

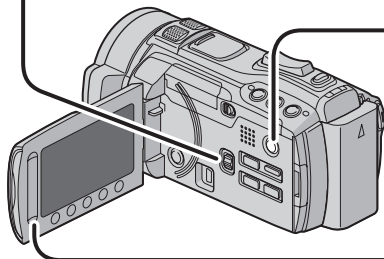

The index screen appears.

- 3** Select the desired file.



- **To move to the previous or next page**
Touch  or  for over a second.





- **To play back a few seconds from the beginning of each video**
Touch **[DIGEST]**.

NOTE









- In some cases, parts of video other than the beginning may be played back.
- Some video may not be played back at all.



- **To delete a video**
Select  when playback is stopped.

- **To change the number of thumbnails** (6 thumbnails/12 thumbnails)
Move the zoom lever to **[W]**.

- **To zoom in the video during pause (Remote Control Only)**
Press **T** on the remote control.
 - Press , , ,  on the remote control to move the zoom area.
 - Press and hold **W** on the remote control to cancel zoom in.

- **Operations during Video Playback — On-screen buttons**

- : Return to the first scene of the file
- : Go to the first scene of the next file
- : Return to the index screen
- : Reverse search (during playback)
- : Frame-by-frame playback in reverse direction (during pause)*
- : Playback
- : Pause
- : Forward search (during playback)
- : Frame-by-frame playback in forward direction (during pause)*

* Slow playback starts when you keep touching the sensor button under  /  for a while.

- **Speaker volume**

+ : Turn up the volume

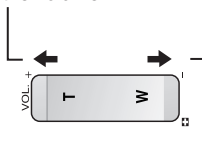

- : Turn down the volume

Still Image Playback

- 1** Slide the mode switch to select  (still image) mode.



- 2** Press **PLAY/REC** to select the playback mode.



The index screen appears.

- 3** Select the desired file.

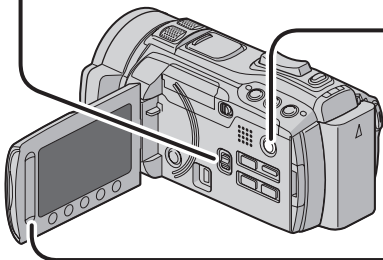

■ To move to the previous or next page

Touch  or  for over a second.

■ To delete a still image

Select .





■ To change the number of thumbnails

(6 thumbnails/12 thumbnails)

Move the zoom lever to [W].

■ To zoom in the image during playback (Remote Control Only)

Press **T** on the remote control.

- Press , , ,  on the remote control to move the zoom area.
- Press and hold **W** on the remote control to cancel zoom in.

■ Operations during Still Image Playback — On-screen buttons

- ◀ : Play the slide show in reverse direction
- ▶ : Play the slide show in forward direction
- : Return to the index screen
- ⏪ : Display the previous file
- ▶ : Start the slide show
- ⏩ : End the slide show
- ⏩ : Display the next file
- ↶ : Rotate 90 degrees counterclockwise (during playback)
- ↷ : Rotate 90 degrees clockwise (during playback)

NOTE

The playback zoom does not function while slide show.

Viewing Files on TV

This camcorder is designed to be used with high-definition or NTSC-type color television signals. It cannot be used with a television of a different standard.

Connection with TV

You can output videos from the HDMI connector, COMPONENT connector, or AV connector. Select the connector that best suits your television.

Preparation:

Turn off all units.

■ To connect using the HDMI mini connector

We recommend using the Category 2 HDMI cable (High Speed cable).

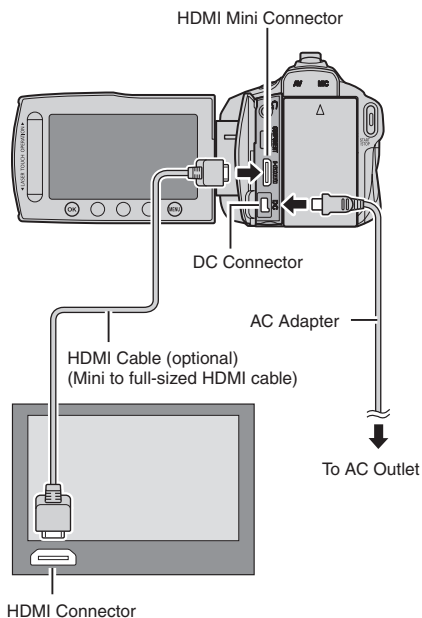

NOTE

- When connecting to the HDMI cable, the image or sound may not appear on the TV properly depending on the TV connected. In such cases, perform the following operations.
 - 1) Disconnect the HDMI cable and connect it again.
 - 2) Turn off and on the camcorder again.

■ To connect using the COMPONENT connector

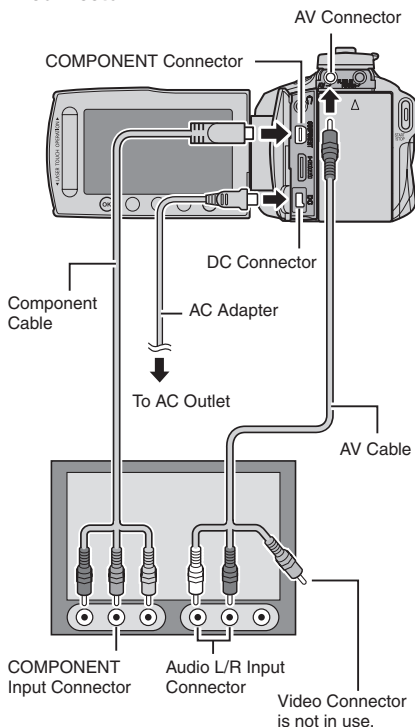

NOTE

Change the settings in [COMPONENT OUTPUT] according to the connection.

■ To connect using the AV connector

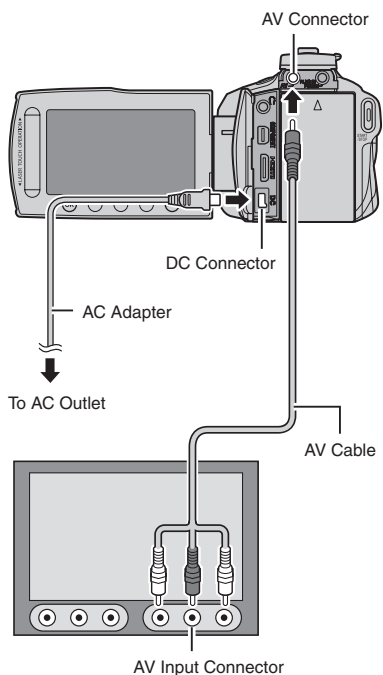

NOTE

Change the settings in [VIDEO OUTPUT] to suit the screen size of your television.

Playback Operation

After the connection with TV is completed

- 1 Turn on the camcorder and the TV.
- 2 Set the TV to its VIDEO mode.
- 3 (Only when connecting the camcorder to the VCR/DVD recorder)
Turn on the VCR/DVD recorder, and set the VCR/DVD recorder to its AUX input mode.
- 4 Start playback on the camcorder. (p. 22, 23)

-
- To display camcorder's on-screen display on TV
Set [DISPLAY ON TV] to [ON].

NOTE

When the video was recorded with x.v.Color™ set to [ON], change the x.v.Color™ setting on TV. For details, refer to the TV's instruction manual.

Copying Files

Types of Copying and Connectable Device

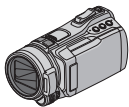

The Camcorder

You can copy files between the built-in memory and the SD card with this camcorder alone.

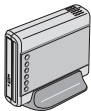

DVD Burner CU-VD50/CU-VD3

You can copy files recorded on this camcorder onto discs.

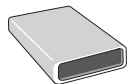

BD Burner LaCie Model No. 301828 LG Model No. BE06LU10

You can copy files recorded on this camcorder onto discs.



USB External Hard Disk Drive

You can copy files recorded on this camcorder onto a USB external hard disk drive.



PC

You can copy files from the camcorder to a disc using a PC.



VCR/DVD Recorder

You can dub video recorded on this camcorder onto VCR/DVD recorder.

NOTE

- It is recommended to use the JVC DVD burner CU-VD50 or CU-VD3. If you use CU-VD20 or CU-VD40, the recording time may take approx. 2 times longer than the time that is described in the instruction manual of DVD burner.
- Recommended USB external hard disk drive

Seagate	FreeAgent™ Desk series
LaCie	Design by Neil Poulton series

- USB external hard disk drive with the capacity over 2 TB cannot be used.

Using a BD/DVD Burner

The files in the camcorder can be backed up to a disc using a BD/DVD burner.

- Use one of the following methods to view the disc. (If you try to play back the disc with incompatible player, the disc may not be ejected.)
 - Playing back the disc in the BD/DVD burner using the camcorder.
 - Playing back the disc using a BD/DVD burner.*
 - Playing back the disc on a PC.*
 - Playing back the disc using a BD/DVD player that supports BD-MV and AVCHD.*
- The DVD must first be finalized using the camcorder's menu.
- Only the BD/DVD created from the camcorder can be played by operating the BD/DVD burner while connected to the Camcorder.
- When connecting the DVD burner CU-VD50 to a TV, you can play back the created disc without using the camcorder. When playing back disconnect the USB cable.

Connection with a BD/DVD Burner

Preparation:

Turn on the camcorder first, then turn on the BD/DVD burner.

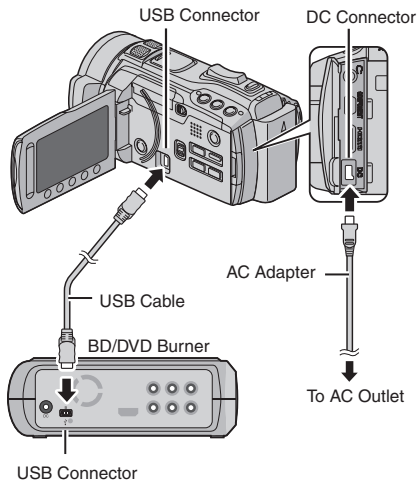

NOTE

- Refer also to the BD/DVD burner's instruction manual.
- When connecting to a DVD burner, use the USB cable that came with the DVD burner.
- When connecting to a BD burner, use a USB cable with Mini-A(Male) to B(Male) connectors. JVC's QAM0852-001 (optional) is recommended. Refer to page 35 for information on contacting JVC.

Backup All Files**Preparation:**

- Select or mode.
- Select built-in memory or SD card to copy from.
- Connect the camcorder to the BD/DVD burner.
- When using a BD burner, select [CHANGE REC. MEDIA] and select the disc type.

- 1 Select [CREATE FROM ALL] (mode) or [SAVE ALL] (mode).



- 2 Select the desired setting.

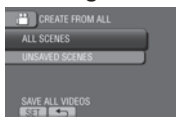

- mode: [ALL SCENES]
 - mode: [ALL IMAGES]
- All files in the recording medium are copied.
- mode: [UNSAVED SCENES]
 - mode: [UNSAVED IMAGES]
- Files that have never been copied are automatically selected and copied.

- 3 Select [EXECUTE].



- 4 Select [YES] or [NO].

- [YES]: Displays the thumbnails by group.
- [NO]: Displays the thumbnails by date or by playlist.

- 5 Select [EXECUTE].

- The files are copied on the disc. When [COMPLETED] appears, touch **OK**.
- When [INSERT NEXT DISC PRESS [STOP] TO EXIT CREATE] appears, change the disc. Remaining files are copied on the second disc.
- To cancel copying, select [STOP].

Copying Video Files that Have Never Been Copied

Files that have never been copied to the discs are automatically selected and copied.

- 1 Press the (Power) button for more than 2 seconds to turn on the camcorder.

- 2 Press DIRECT DISC.

DIRECT DISC



INFO

- 3 Select [YES] or [NO].

- [YES]: Displays the thumbnails by group.
- [NO]: Displays the thumbnails by date or by playlist.

- 4 Select [EXECUTE].



- The files are copied on the disc. When [COMPLETED] appears, touch **OK**.
- When [INSERT NEXT DISC PRESS [STOP] TO EXIT CREATE] appears, change the disc. Remaining files are copied on the second disc.
- To cancel the disc creation, select [CANCEL].

Copying Files (Continued)

■ To quit the screen

- 1) Select [QUIT].
- 2) When [QUIT?] appears, select [YES].

NOTE

This method can be used to copy video files to discs in a computer connected to the camcorder.

Dubbing Files to a VCR/DVD Recorder

Preparation:

- Create a playlist.
- Turn off all units.

■ To connect using the AV connectors (analog dubbing)

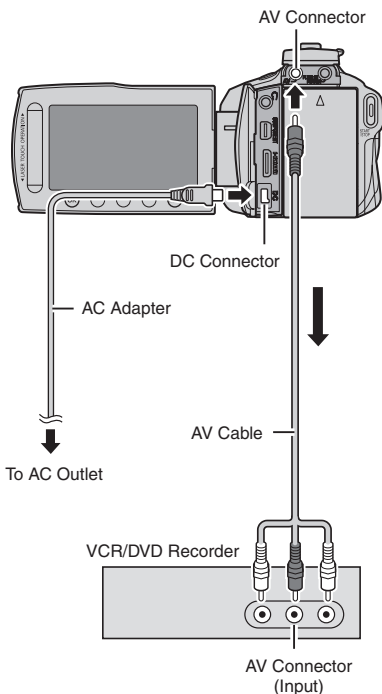

1 Press the \odot (Power) button for more than 2 seconds to turn on the camcorder.

2 Set the VCR/DVD recorder to its AUX input mode.

Check that the images from the camcorder are input correctly to the VCR/DVD recorder.

3 Play back playlists on the camcorder.

- 1) Touch **MENU**.
- 2) Select [DUBBING PLAYBACK].
- 3) Select the desired playlist.
- 4) Select [YES]. (A black screen is displayed for 5 seconds at the beginning and the end of the footage.)

4 At the point you want to start dubbing, start recording on the VCR/DVD recorder.

Refer to the VCR/DVD recorder's instruction manual.

■ To stop dubbing

Stop recording on the VCR/DVD recorder.

■ To hide the date or icons on the screen

Change the settings in [DISPLAY ON TV] before dubbing.

Switching indication modes on LCD monitor

Each time you touch **DISPLAY**, indications on LCD monitor switch as shown below:

In recording mode:

All indications/Indications for selected functions

In playback mode:

All indications/Only date and time/No indications

Creating a Disc Using a PC

You can copy the data from the camcorder and create a disc using a PC.

1 Installing the software to the PC

System Requirements

Windows Vista

OS: Windows Vista®
Home Basic (SP1)
Home Premium (SP1)
(32-bit, pre-installed)

CPU: Intel® Core™ Duo, 1.66 GHz or higher
(Intel® Core™ 2 Duo 2.13 GHz or higher recommended.)

RAM: At least 2 GB

Windows XP

OS: Windows® XP
Home Edition (SP2/SP3)
Professional (SP2/SP3)
(pre-installed)

CPU: Intel® Core™ Duo, 1.66 GHz or higher
(Intel® Core™ 2 Duo 2.13 GHz or higher recommended.)

RAM: At least 1 GB

■ To check the PC specification

Right-click on [Computer] (or [My Computer]) in the [Start] menu and select [Properties].

NOTE

- Make sure your PC has a recordable BD/DVD drive.
- If your system does not meet the requirements, it is recommended to copy files using a BD/DVD burner. (p. 26)

Preparation:

Load the provided CD-ROM into the PC. In Windows Vista, the auto play dialog box appears.

1 Click [Easy Installation].



Follow the on-screen instructions.

2 Click [Next].



3 Click [Finish].



Everio MediaBrowser icons are created on the desktop.



Everio MediaBrowser Player is a software that plays AVCHD discs on the PC. (DVD discs cannot be played.)

■ To see the Instruction Guide for Everio MediaBrowser

- 1) Double-click the icon of Everio MediaBrowser.
- 2) Click [Help], and click [MediaBrowser Help].



Creating a Disc Using a PC (Continued)

2 Making Backup on the PC

Preparation:

- Install the software to the PC.
- Make sure that enough free space is left in the PC's HDD.
- Press the \odot (Power) button for more than 2 seconds to turn off the camcorder.

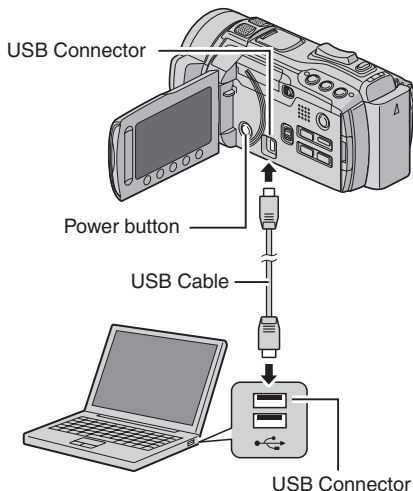

1 Press the \odot (Power) button for more than 2 seconds to turn on the camcorder.

2 Select [BACK UP].

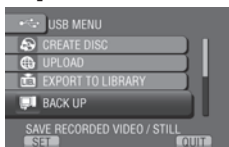

Everio MediaBrowser starts on the PC.



3 Click [All volume in camcorder] and click [Next].



4 Click [Start].



Backup starts.

To disconnect the camcorder from the PC

- 1) Right-click the icon (Safely Remove Hardware) on the task bar and select [Safely remove USB Mass Storage Device].
- 2) Follow the on-screen instructions and make sure that the device can be safely removed.
- 3) Disconnect the USB cable and close the LCD monitor.

NOTE

It takes time to back up many videos.

1 Making User Lists to Arrange the Files

You can make a user list of a certain subject (such as Travel, Athletic meet) and put the files related to the subject into the user list.

Preparation:

Make backup on the PC.

1 Double-click the icon to open the calendar.



2 Select [Movies only].



3 Click [+].



4 Input the name of the new user list and click [OK].

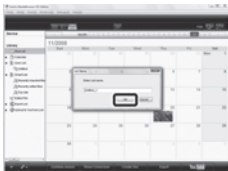

5 Click the recording date.



The files recorded on the day are displayed.

6 Drag and drop the file into the user list.



To add other files into the user list, repeat steps 5 and 6.

Creating a Disc Using a PC (Continued)

1 Copying Files to a disc

Everio MediaBrowser supports 3 disc formats. Select the one that suits your purpose.

DVD-Video disc: Suitable if you will give the disc to your friends and relatives.

AVCHD disc: Suitable for high quality video.

BD: Suitable for high quality video with long recording time.

1 Select the user list and click [Create Disc].



2 Select the disc type and click [Next].



3 Click [Select files individually] and click [Next].

To add all the files onto discs, click [Select all files displayed], then go to step 5.



4 Drag and drop the file, into the part at the bottom and click [Next].



5 Input the disc name, select the top menu style and click [Next].



6 Click [Start].



NOTE

- When copying video recorded in UXP recording mode to create an AVCHD disc, the video needs to be converted to XP recording mode before copying. Therefore, it may take longer time than copying video recorded in other modes.
- Use Everio MediaBrowser Player to play back the disc. Refer to the help of the provided Everio MediaBrowser software to operate.
- For detail on operating Everio MediaBrowser, click [Help] and refer to [MediaBrowser Help].
- Adobe® Reader® must be installed to read [MediaBrowser Help]. Adobe® Reader® can be downloaded from Adobe's web site: <http://www.adobe.com>
- For assistance in operating the provided software, refer to the support information. (p. 35)

Folder Structure and Extensions

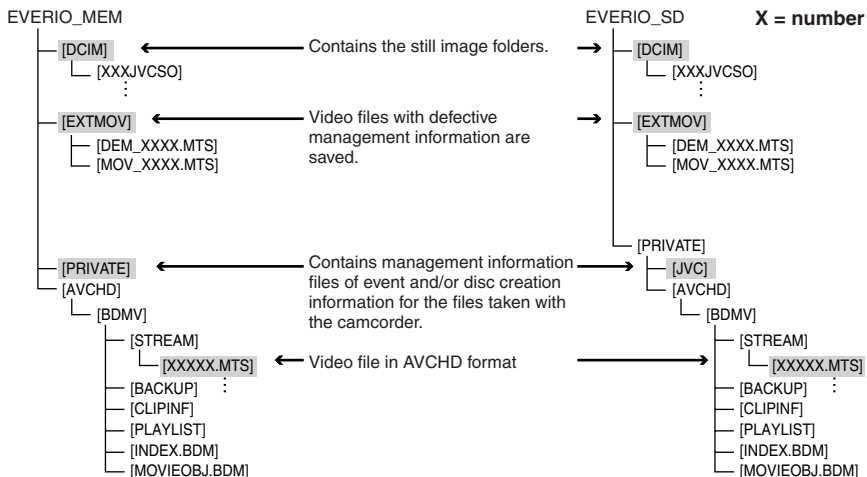

For Macintosh users

■ To copy files to a computer

- 1) Connect the camcorder to the computer with the USB cable.
- 2) Select [PLAYBACK ON PC].
- 3) Click [EVERIO_MEM/EVERIO_SD] displayed on the computer screen.
- 4) Click .

Search the files you want referring the folder structure above.

- 5) Copy files to any folder on the PC (such as the desktop).

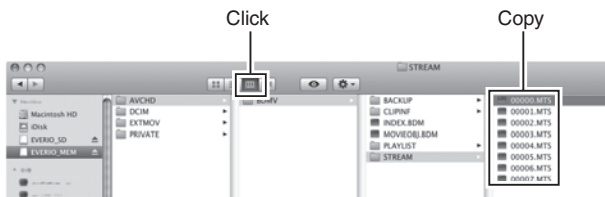

(The screen is the image of Mac OS X.)

■ To edit files

Use the software compatible with AVCHD/JPEG.

NOTE

Do not move or delete the folders and the files in the camcorder.

Using with a Portable Media Player

Turning on the Export Mode

You can easily transfer videos recorded in export mode to iTunes®. All the files with the export setting turned on are transferred to PC. For details on transferring, refer to the help of Everio MediaBrowser in the CD-ROM.

Preparation:

- Select **mode**.
- Select the recording mode.

Press EXPORT twice.

EXPORT



To turn off the export mode

Press **EXPORT** twice.

Making the Export Setting

You can set the recorded videos to be exported to iTunes®.

Preparation:

- Select **mode**.
- Select the playback mode.

1 Press EXPORT.

EXPORT



2 Select the file and select [LIB.].

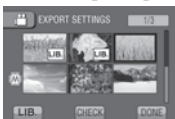

To check the content of the file, select [CHECK].

3 Select [DONE].

To cancel the export setting

Select the file and select [LIB.] again.

To quit the screen

- 1) Select [DONE].
- 2) Select [YES].

To confirm the export setting

Press **EXPORT** on the index screen.

Transferring the Files to PC

Preparation:

Install iTunes® on a PC.

<http://www.apple.com/itunes/>

1 Connect the camcorder to the PC with the USB cable.

2 Select [EXPORT TO LIBRARY].

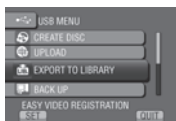

All the files with the export setting turned on are transferred to PC.

If you cannot export the file to iTunes®

Refer to "Q&A", "Latest Information", "Download Information", etc. in [Click for Latest Product Info] in the help of the provided Everio MediaBrowser software.

Uploading Files to Websites



Turning on the Upload Mode

You can upload the file to video sharing websites (YouTube™) easily after recording.

Preparation:

- Select mode.
- Select the recording mode.

Press **UPLOAD** twice.

UPLOAD
/TITLE



If you record a file with the upload mode set on, the recording stops automatically 10 minutes after the recording is started. The remaining time is displayed on the LCD monitor.

NOTE

The upload mode turns off each time recording is finished.

Uploading Files

For details on uploading files, refer to the help of Everio MediaBrowser in the CD-ROM.

- 1 **Connect the camcorder to the PC with the USB cable.**
- 2 **Select [UPLOAD].**



If you cannot upload the file to YouTube™

- You need your YouTube™ account to upload files to YouTube™. Create your account.
- Refer to “Q&A”, “Latest Information”, “Download Information”, etc. in [Click for Latest Product Info] in the help of the provided Everio MediaBrowser software.

Customer Support Information

Use of this software is authorized according to the terms of the software license.

JVC

When contacting the nearest JVC office or agency in your country (refer to the JVC Worldwide Service Network at <http://www.jvc-victor.co.jp/english/worldmap/index-e.html>) about this software, please have the following information ready.

- Product Name, Model, Problem, Error Message
- PC (Manufacturer, Model (Desktop/Laptop), CPU, OS, Memory (MB), Available Hard Disk Space (GB))

Please note that it may take some time to respond to your questions, depending on their subject matter. JVC cannot answer questions regarding basic operation of your PC, or questions regarding specifications or performance of the OS, other applications or drivers.

Pixela

Region	Language	Phone #
USA and Canada	English	+1-800-458-4029 (toll-free)
Europe (UK, Germany, France, and Spain)	English/German/French/Spanish	+800-1532-4865 (toll-free)
Other Countries in Europe	English/German/French/Spanish/ Italian/Dutch	+44-1489-564-764
Asia (Philippines)	English	+63-2-438-0090
China	Chinese	10800-163-0014 (toll-free)

Homepage: <http://www.pixela.co.jp/oem/jvc/mediabrowser/e/>

Please check our website for latest information and downloading.

Changing the Menu Settings

1 Touch MENU.

2 Select the desired menu.



■ To return to the previous screen

Select

■ To quit the screen

Select [QUIT].

3 Select the desired setting.

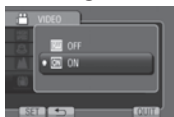

Troubleshooting

Before requesting service, consult the following chart. If the solutions indicated in the chart do not solve the problem, consult your nearest JVC dealer or JVC service center for instructions. Refer also to the FAQ of new products on JVC's website.

The following phenomena are not malfunctions.

- The camcorder heats up when it is used for a long time.
- The battery heats up during charging.
- When playing back a video, the image stops momentarily or the sound is interrupted at junctions between scenes.
- LCD monitor momentarily become red or black when sunlight is recorded.
- Black spots, or red, green, or blue spots appear on the LCD monitor.
(The LCD monitor contains 99.99% effective pixels, but 0.01% or fewer pixels may be ineffective.)

FURTHER INFORMATION

Trouble		Action
Power	No power is supplied.	<ul style="list-style-type: none"> • Connect the AC adapter correctly. • Recharge the battery pack.
	The power/charge lamp blinks when the LCD monitor is closed.	<ul style="list-style-type: none"> • [QUICK RESTART] is set to [ON]. • The battery is being charged.
Display	The remaining battery display is not correct.	<ul style="list-style-type: none"> • Fully charge the battery pack, run it down, and then recharge it again. • If the camcorder is used for long periods of time in high or low temperatures, or if the battery pack is repeatedly charged, the amount of remaining battery may not be displayed correctly.
	The LCD monitor is difficult to see.	<ul style="list-style-type: none"> • The LCD monitor may be difficult to see if used in bright areas such as under direct sunlight.

	Trouble	Action
Recording	Recording cannot be performed.	<ul style="list-style-type: none"> Slide the mode switch to select the desired mode (👤 or 📷).
	Vertical lines appear on recorded images.	<ul style="list-style-type: none"> Such phenomenon occurs when shooting a subject illuminated by bright light. This is not a malfunction.
Playback	Sound or video are interrupted.	<ul style="list-style-type: none"> Sometimes playback is interrupted at the connecting section between two scenes. This is not a malfunction.
	Cannot find a recorded video.	<ul style="list-style-type: none"> Select [PLAYBACK OTHER FILE] then search the video on the index screen. (Video files that have damaged management information can be played back.) Cancel group display and date search functions. Change the setting in [REC MEDIA FOR VIDEO] or [REC MEDIA FOR IMAGE]. (Files on other media are not displayed.)
Other problems	The camcorder operates slowly when switching between video mode and still image mode, or when switching the power on or off.	<ul style="list-style-type: none"> If there are many files (such as video) in the camcorder, it takes time for the camcorder to respond. It is recommended that you copy all files from the camcorder onto your computer, and erase the files from the camcorder.
	The lamp does not flash during battery pack charging.	<ul style="list-style-type: none"> Check the remaining battery pack charge. (When the battery pack is fully charged, the lamp does not flash.) When recharging in either a hot or cold environment, ensure that battery is being charged within the permitted temperature range. (If the battery pack is being recharged outside the permitted temperature range, recharging may stop to protect the battery pack.)
	The remote control does not work.	<ul style="list-style-type: none"> Replace the battery. Set [REMOTE] to [ON]. The remote control may not operate outdoors or in places exposed to strong light.
	Cannot upload the file to YouTube™.	<ul style="list-style-type: none"> You need your YouTube™ account to upload files to YouTube™. Create your account. Refer to “Q&A”, “Latest Information”, “Download Information”, etc. in [Click for Latest Product Info] in the help of the provided Everio MediaBrowser software.
	Cannot export the file to iTunes®.	<ul style="list-style-type: none"> Refer to “Q&A”, “Latest Information”, “Download Information”, etc. in [Click for Latest Product Info] in the help of the provided Everio MediaBrowser software.

■ **If a malfunction occurs in the built-in memory**

- ① Perform [FORMAT BUILT-IN MEM.]. (All data is deleted.)
- ② If this does not solve the problem, contact the JVC customer service for repairs.

■ **To reset the camcorder when it does not operate normally**

- ① Close the LCD monitor and remove the power supply (battery pack or AC adapter) from the camcorder, then reattach it.
- ② Execute [FACTORY PRESET].

Warning Indications

Indication	Action
SET DATE/TIME!	<ul style="list-style-type: none"> ● Set the clock. If the message still appears after setting the clock, the battery for the clock has been depleted. Consult your nearest JVC dealer.
COMMUNICATING ERROR	<ul style="list-style-type: none"> ● Be sure to use JVC battery packs.
CANNOT USE IN VIDEO MODE	<ul style="list-style-type: none"> ● Set [REC MEDIA FOR VIDEO] to [BUILT-IN MEMORY]. ● Replace the SD card. (Files recorded with other devices that support AVCHD cannot be played back on this camcorder.)
NOT FORMATTED	<ul style="list-style-type: none"> ● Select [OK] and select [YES] to perform formatting.
FORMAT ERROR!	<ul style="list-style-type: none"> ● Check the operating procedure, and perform once again. ● Turn off the camcorder, and turn it on again.
DATA DELETION ERROR	
ERROR IN BUILT-IN MEMORY!	<ul style="list-style-type: none"> ● Perform formatting. (All data is deleted.) ● Turn off the camcorder, and turn it on again.
MEMORY CARD ERROR!	<ul style="list-style-type: none"> ● Perform formatting. (All data is deleted.) ● Remove and re-insert the SD card. (MultiMediaCard cannot be used.) ● Remove any dirt from the SD card terminals. ● Insert the SD card before switching the power on. ● Turn off the camcorder, and turn it on again. ● Do not change the folder name on a computer.
RECORDING CANCELLED	<ul style="list-style-type: none"> ● Turn off the camcorder and turn it on again. ● Prevent the camcorder from vibration and shock.
RECORDING FAILURE	<p>SD card:</p> <ul style="list-style-type: none"> ● Remove and re-insert the SD card. (MultiMediaCard cannot be used.) ● Remove any dirt from the SD card terminals. ● Insert the SD card before switching the power on. <p>Built-in memory:</p> <ul style="list-style-type: none"> ● Do not allow the camcorder to be subject to impact/vibrations.
PLAYBACK FAILED	
INSUFFICIENT SPACE	<ul style="list-style-type: none"> ● Delete files. Move files to a PC or other devices. ● Replace the SD card with a new one.
VIDEO MANAGEMENT FILE IS DAMAGED, RECOVERY IS REQUIRED TO RECORD/PLAYBACK, RECOVER?	<ul style="list-style-type: none"> ● Select [OK] to restore.

Specifications

■ General

Power supply

- DC 11 V (Using AC adapter)
- DC 7.2 V (Using battery pack)

Power consumption

- Approx. 4.0 W*
- * When the monitor backlight is set to [STANDARD] mode.
- Rated Current Consumption: 1A

Dimensions (W x H x D)

- 67 mm x 72 mm x 135 mm
- (2-11/16" x 2-7/8" x 5-3/8")

Weight

- Approx. 400 g (0.89 lbs)
- Approx. 485 g (1.07 lbs) (incl. battery pack)

Operating temperature

- 0°C to 40°C (32°F to 104°F)

Storage temperature

- 20°C to 50°C (-4°F to 122°F)

Operating humidity

- 35% to 80%

■ Camera/LCD monitor

Pickup

- 1/2.33" (10,290,000 pixels) progressive CMOS

Lens

- F 2.8 to 4.5, f = 6.7 mm to 67.0 mm,
- 10:1 power zoom lens

Filter diameter

- ø46 mm

LCD monitor

- 2.8" diagonally measured,
- LCD panel/TFT active matrix system

Flash

- Within 2 m (6.6 ft)
- (recommended shooting distance)

■ Connectors

AV output

- Video output: 1.0 V (p-p), 75 Ω
- Audio output: 300 mV (rms), 1 kΩ

HDMI

- HDMI™ (V.1.3 with x.v.Color™)

Component output

- Y, Pb, Pr component output
- Y: 1.0 V (p-p), 75 Ω
- Pb/Pr: 700 mV (p-p), 75 Ω

USB

- Mini USB type A and type B,
- USB 2.0 compliant

Headphones

- ø3.5 mm mini-jack, stereo, analog output

Microphone

- ø3.5 mm mini-jack, stereo, analog input

■ AC Adapter

Power requirement

- AC 110 V to 240 V~, 50 Hz/60 Hz

Output

- DC 11 V , 1 A

■ Remote Control

Power supply

- DC 3 V

Battery life

- Approx. 1 year
- (depending on the frequency of use)

Operating distance

- Within 4 m (13.16 ft)

Operating temperature

- 0°C to 40°C (32°F to 104°F)

Dimensions (W x H x D)

- 42 mm x 14.5 mm x 91 mm
- (1-11/16" x 5/8" x 3-5/8")

Weight

- Approx. 30 g (0.07 lbs)
- (incl. battery)

■ Still image

Format

- JPEG

Image size

- 4:3 mode: 3456 x 2592 / 3072 x 2304 / 2592 x 1944 / 1600 x 1200 / 640 x 480
- 16:9 mode: 3456 x 1944 / 3072 x 1728 / 2592 x 1456 / 1920 x 1080 / 1280 x 720

Image quality

- FINE / STANDARD

■ Video

Signal format

- 1080/60i

Recording/Playback format

- Video: MPEG-4 AVC/H.264
- Audio: Dolby Digital (2ch)

Recording mode (video)

- UXP: VBR, average of 24 Mbps
- XP: VBR, average of 17 Mbps
- SP: VBR, average of 12 Mbps
- EP: VBR, average of 5 Mbps

Recording mode (audio)

- 48 kHz, 256 kbps

Design and specifications subject to change without notice.

Specifications (Continued)

h: hour/m: minute

Approximate recordable time (for video)

Recording medium \ Quality	Built-in Memory	SDHC Card			
	32 GB	4 GB	8 GB	16 GB	32 GB
UXP	2 h 56 m	20 m	40 m	1 h 20 m	2 h 40 m
XP	4 h 9 m	30 m	1 h 00 m	2 h 00 m	4 h 00 m
SP	5 h 53 m	44 m	1 h 28 m	2 h 56 m	5 h 52 m
EP	14 h 44 m	1 h 50 m	3 h 40 m	7 h 20 m	14 h 40 m

Approximate number of images (for still image)

Recording medium \ Image size/Quality	Built-in Memory	SD Card			SDHC Card				
	32 GB	512 MB	1 GB	2 GB	4 GB	8 GB	16 GB	32 GB	
16:9	3456 x 1944 / FINE	9999	160	320	640	1270	2570	5180	9999
	3456 x 1944 / STANDARD	9999	250	500	1030	2030	4090	8260	9999
	3072 x 1728 / FINE	9999	200	400	820	1620	3260	6590	9999
	3072 x 1728 / STANDARD	9999	320	640	1290	2550	5140	9999	9999
	2592 x 1456 / FINE	9999	280	570	1150	2260	4560	9200	9999
	2592 x 1456 / STANDARD	9999	440	890	1790	3530	7100	9999	9999
	1920 x 1080 / FINE	9999	510	1030	2100	4140	8330	9999	9999
	1920 x 1080 / STANDARD	9999	810	1620	3210	6310	9999	9999	9999
	1280 x 720 / FINE	9999	1190	2400	4690	9230	9999	9999	9999
	1280 x 720 / STANDARD	9999	1760	3530	6780	9999	9999	9999	9999
4:3	3456 x 2592 / FINE	7730	120	240	480	960	1930	3860	7810
	3456 x 2592 / STANDARD	9999	190	380	770	1510	3050	6110	9999
	3072 x 2304 / FINE	9760	150	300	610	1210	2440	4880	9860
	3072 x 2304 / STANDARD	9999	240	480	980	1930	3890	7790	9999
	2592 x 1944 / FINE	9999	210	420	870	1710	3450	6900	9999
	2592 x 1944 / STANDARD	9999	340	680	1380	2720	5490	9999	9999
	1600 x 1200 / FINE	9999	550	1110	2260	4440	8950	9999	9999
	1600 x 1200 / STANDARD	9999	880	1760	3590	7060	9999	9999	9999
	640 x 480 / FINE	9999	3330	6670	9999	9999	9999	9999	9999
	640 x 480 / STANDARD	9999	5990	9999	9999	9999	9999	9999	9999

The recordable time and the number of still images are approximate and may differ depending on the recording environment, the condition of the built-in memory or the SD card, or the remaining battery power.

h: hour/m: minute

Required charging/recording time (approx.)

Battery pack	Charging time	Recording time
BN-VF808U	1 h 50 m	1 h 10 m*
BN-VF815U (Provided)	2 h 40 m	2 h 25 m*
BN-VF823U	3 h 40 m	3 h 40 m*

* When the monitor backlight is set to [STANDARD] mode.

Cautions

AC Adapter

When using the AC adapter in areas other than the USA

The provided AC adapter features automatic voltage selection in the AC range from 110 V to 240 V.

USING HOUSEHOLD AC PLUG ADAPTER

In case of connecting the unit's power cord to an AC wall outlet other than American National Standard C73 series type use an AC plug adapter, called a "Siemens Plug", as shown.

For this AC plug adapter, consult your nearest JVC dealer.

Plug Adapter

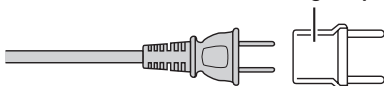

Battery Pack

The supplied battery pack is a lithium-ion battery. Before using the supplied battery pack or an optional battery pack, be sure to read the following cautions:

Terminals

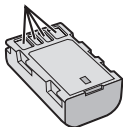

• To avoid hazards

... do not burn.

... do not short-circuit the terminals. Keep it away from metallic objects when not in use. When transporting, make sure the provided battery cap is attached to the battery. If the battery cap is misplaced, carry the battery in a plastic bag.

... do not modify or disassemble.

... do not expose the battery to temperatures exceeding 60°C (140°F), as this may cause the battery to overheat, explode or catch fire.

... use only specified chargers.

• To prevent damage and prolong service life

... do not subject to unnecessary shock.

... charge within the temperature range of 10°C to 35°C (50°F to 95°F). Cooler temperatures require longer charging time, or in some cases stop charging at all.

Warmer temperatures prevent complete charging, or in some cases stop charging at all. ... store in a cool, dry place. Extended exposure to high temperatures will increase natural discharge and shorten service life.

... fully charge and then fully discharge the battery every 6 months when storing the battery pack over a long period of time.

... remove from charger or powered unit when not in use, as some machines use current even when switched off.

ATTENTION:



The product you have purchased is powered by a rechargeable battery that is recyclable.

Please call 1-800-8-BATTERY for information on how to recycle this battery.

Recording Medium

• Be sure to follow the guidelines below to prevent corruption or damage to your recorded data.

- Do not bend or drop the recording medium, or subject it to strong pressure, jolts or vibrations.
- Do not splash the recording medium with water.
- Do not use, replace, or store the recording medium in locations that are exposed to strong static electricity or electrical noise.
- Do not turn off the camcorder power or remove the battery or AC adapter during shooting, playback, or when otherwise accessing the recording medium.
- Do not bring the recording medium near objects that have a strong magnetic field or that emit strong electromagnetic waves.
- Do not store the recording medium in locations with high temperature or high humidity.
- Do not touch the metal parts.
- When formatting or erasing data using the camcorder, only the file administration information is changed. The data is not completely erased from the hard disk. If you want to completely erase all of the data, we recommend either using commercially available software that is specially designed for that purpose, or by physically destroying the camcorder with a hammer etc.

LCD Monitor

• To prevent damage to the LCD monitor, DO NOT

... push it strongly or apply any shocks.

... place the camcorder with LCD monitor on the bottom.

• To prolong service life

... avoid rubbing it with coarse cloth.

Main Unit

● For safety, DO NOT

- ... open the camcorder's chassis.
- ... disassemble or modify the unit.
- ... allow inflammables, water or metallic objects to enter the unit.
- ... remove the battery pack or disconnect the power supply while the power is on.
- ... leave the battery pack attached when the camcorder is not in use.
- ... place naked flame sources, such as lighted candles, on the apparatus.
- ... expose the apparatus to dripping or splashing.
- ... leave dust or metal objects adhered to the power plug or an AC wall outlet.
- ... insert any objects in the camcorder.

● Avoid using the unit

- ... in places subject to excessive humidity or dust.
- ... in places subject to soot or steam such as near a cooking stove.
- ... in places subject to excessive shock or vibration.
- ... near a television set.
- ... near appliances generating strong magnetic or electric fields (speakers, broadcasting antennas, etc.).
- ... in places subject to extremely high (over 40°C or 104°F) or extremely low (under 0°C or 32°F) temperatures.

● DO NOT leave the unit

- ... in places of over 50°C (122°F).
- ... in places where humidity is extremely low (below 35%) or extremely high (above 80%).
- ... in direct sunlight.
- ... in a closed car in summer.
- ... near a heater.
- ... in high places such as on a TV. Leaving the unit in high places while a cable is connected may result in a malfunction if the cable is caught and the unit falls onto the floor.

● To protect the unit, DO NOT

- ... allow it to become wet.
- ... drop the unit or strike it against hard objects.
- ... subject it to shock or excessive vibration during transportation.
- ... keep the lens directed at extremely bright objects for long periods.
- ... expose the lens to direct sunlight.
- ... swing it excessively when using the hand strap.
- ... swing the soft camcorder case excessively when the camcorder is inside it.
- ... place the camcorder in dusty or sandy areas, such as on a beach.

● To prevent the unit from dropping,

- Fasten the grip belt securely.
 - When using the camcorder with a tripod, attach the camcorder to the tripod securely.
- If the camcorder drops, you may be injured and the camcorder may be damaged.
When a child uses the unit, there must be parental guidance.

Declaration of Conformity

Model Number : GZ-HM400U

Trade Name : JVC

Responsible party : JVC AMERICAS CORP.

Address : 1700 Valley Road Wayne, N. J. 07470

Telephone Number : 973-317-5000

This device complies with Part 15 of FCC Rules. Operation is subject to the following two conditions: (1) This device may not cause harmful interference, and (2) this device must accept any interference received, including interference that may cause undesired operation.

Changes or modifications not approved by JVC could void the user's authority to operate the equipment. This equipment has been tested and found to comply with the limits for a Class B digital device, pursuant to Part 15 of the FCC Rules. These limits are designed to provide reasonable protection against harmful interference in a residential installation. This equipment generates, uses, and can radiate radio frequency energy and, if not installed and used in accordance with the instructions, may cause harmful interference to radio communications. However, there is no guarantee that interference will not occur in a particular installation. If this equipment does cause harmful interference to radio or television reception, which can be determined by turning the equipment off and on, the user is encouraged to try to correct the interference by one or more of the following measures: Reorient or relocate the receiving antenna. Increase the separation between the equipment and receiver. Connect the equipment into an outlet on a circuit different from that to which the receiver is connected. Consult the dealer or an experienced radio/TV technician for help.

This Class B digital apparatus complies with Canadian ICES-003.

Cet appareil numérique de la classe B est conforme à la norme NMB-003 du Canada.

Terms

A	AC Adapter	16, 42	N	Number of Images	40
	AV Connection	25, 28	O	On-screen Recording Control	19
B	Battery Pack	16, 42		On-screen Zoom Control	21
	BD/DVD Backup	26	P	Playback Zoom	22, 23
	BD/DVD Burner	26		Portable Media Player	34
C	CD-ROM	10, 29	Q	Quick Review	19, 20
	Clock Adjust	16	R	Recordable Time	40
	Component Connection	24		Recording Medium	42
	Copying Files	26		Remaining Battery Power	21
D	Date/Time Setting	5		Remaining Recording Time	21
	Digest Playback	22		Remote Control	11, 13
	Dubbing Playback	28	S	SD Card	18
E	Export to Library Mode	34		Speaker Volume	22
F	Flash	21	U	Uploading Files	35
H	HDMI	24		USB Cable	26, 30
I	iTunes	34	V	Viewing Files on TV	24
L	Language Setting	17	Y	YouTube	35
	LCD Monitor	14, 42	Z	Zoom	21
M	Menu Settings	36			

JVC